

## Dati Tecnici - Specifications

	cond	comp. W	ABS. W	Fuse	Kwh/100Kg	l / h	kg	Lbs	kg	Lbs	Ton CO2 equiv.
JS20 A		559	440	10	42.4	2.46	28	62	33	73	0.286
JS20 W		559	360	10	38.0	28.1	28	62	33	73	0.260

## 24h Produzione Ghiaccio - Ice Production

### Raffreddamento ad aria - Air Cooled Unit

Temp. aria Air Temp.	Temp. acqua / Water Temp.			
	32°	21°	15°	10°
°C	32°	21°	15°	10°
°F	90°	70°	60°	50°
10°	<b>18</b>	<b>19</b>	<b>20</b>	<b>21</b>
50°	40	42	44	46
21°	<b>16.5</b>	<b>17.5</b>	<b>18.5</b>	<b>19.5</b>
70°	36	39	41	43
32°	<b>14</b>	<b>15</b>	<b>16</b>	<b>17</b>
90°	31	33	35	37
38°	<b>11</b>	<b>12</b>	<b>13</b>	<b>14</b>
100°	24	26	29	31

### Raffreddamento ad acqua - Water Cooled Unit

Temp. aria Air Temp.	Temp. acqua / Water Temp.			
	32°	21°	15°	10°
°C	32°	21°	15°	10°
°F	90°	70°	60°	50°
10°	<b>18</b>	<b>19</b>	<b>20</b>	<b>21</b>
50°	40	42	44	46
21°	<b>16</b>	<b>17</b>	<b>18</b>	<b>19</b>
70°	35	37	40	42
32°	<b>15.5</b>	<b>16.5</b>	<b>17.5</b>	<b>18.5</b>
90°	34	36	39	41
38°	<b>13</b>	<b>14</b>	<b>15</b>	<b>16</b>
100°	29	31	33	35



### PANNELLO DI CONTROLLO - CONTROL PANEL



Interruttore On/OFF  
Switch ON/OFF

Vite regolazione  
dimensione ghiaccio  
Size ice regulation screw

### CAPACITA' DEPOSITO - BIN CAPACITY

6,5 Kg - 14,3 lbs / 325 pcs

### DIMENSIONI - DIMENSIONS

LxPxH(mm): 340 x 480 x 605

WxDxH(in): 13" 6/16 x 19" 14/16 x 24" 13/16

### DATI SPEDIZIONE / SHIPPING DATA

LxPxH(mm): 400 x 530 x 760

WxDxH(in): 16" 12/16 x 21" 14/16 x 30" 15/16

### TIPO GHIACCIO - ICE TYPE

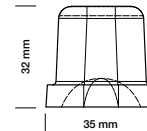

**20g**

PESO GHIACCIO  
WEIGHT ICE

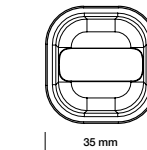

**18**

PZ / CICLO  
PCS / CYCLE

### CONDIZIONI USO-OPERATING REQUIREMENTS



220-240V / 50Hz / 1



R134a GWP=1430

MIN

MAX

10°C (50°F)



40°C (104°F)

5°C (41°F)



35°C (95°F)

- 10 %



+ 10 %

1 BAR (14 PSI)



5 BAR (70 PSI)

Calore espulso - Rejected Heat  
Volume aria - Air Volume

**977 W**  
**185 m³/h**

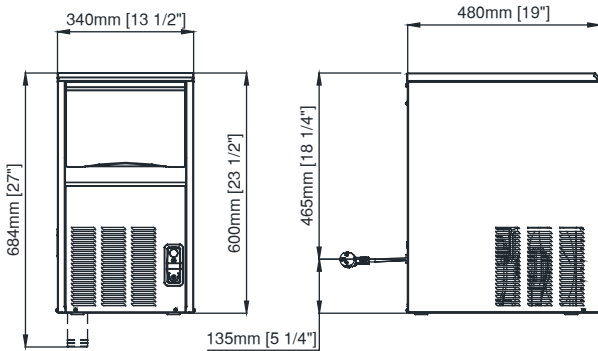

Kit 4 Feet Optional  
Kit 4 piedini Optional  
Ø50mm H100-120 mm

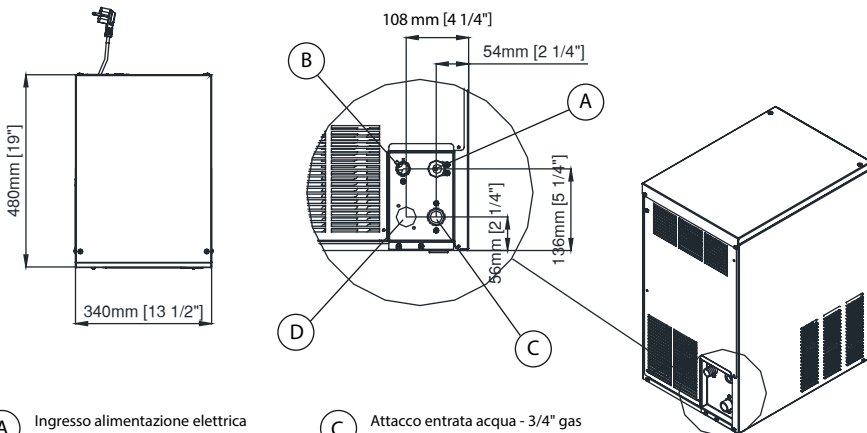

- A** Ingresso alimentazione elettrica  
Electrical cable supply
- B** Attacco scarico acqua Ø 20 mm  
Water outlet connection Ø 20 mm

- C** Attacco entrata acqua - 3/4" gas  
Water inlet connection - 3/4" gas
- D** Uscita acqua condensatore ad acqua Ø 20 mm  
Water outlet connection water condensation Ø 20 mm

## Dati Tecnici - Specifications

	cond	comp. W	ABS. W	Fuse	Kwh/100Kg	l / h	kg	Lbs	kg	Lbs	Ton CO2 equiv.
JS25 A		679	460	10	42.7	2,08	34	75	42	93	0.329
JS25 W		679	410	10	37.5	32,3	34	75	42	93	0.286

## 24h Produzione Ghiaccio - Ice Production

### Raffreddamento ad aria - Air Cooled Unit

Temp. aria Air Temp.	Temp. acqua / Water Temp.			
	32°	21°	15°	10°
°C	32°	21°	15°	10°
°F	90°	70°	60°	50°
10°	<b>17</b>	<b>21</b>	<b>22</b>	<b>24</b>
50°	37	46	49	53
21°	<b>16</b>	<b>20</b>	<b>21</b>	<b>23</b>
70°	35	44	46	51
32°	<b>14</b>	<b>18</b>	<b>19</b>	<b>21</b>
90°	31	40	42	46
38°	<b>12</b>	<b>15</b>	<b>16</b>	<b>17</b>
100°	26	33	35	37

### Raffreddamento ad acqua - Water Cooled Unit

Temp. aria Air Temp.	Temp. acqua / Water Temp.			
	32°	21°	15°	10°
°C	32°	21°	15°	10°
°F	90°	70°	60°	50°
10°	<b>20</b>	<b>20.5</b>	<b>21.5</b>	<b>22.5</b>
50°	44	45	47	50
21°	<b>19.5</b>	<b>20</b>	<b>21</b>	<b>22</b>
70°	43	44	46	49
32°	<b>16.5</b>	<b>17.5</b>	<b>18.5</b>	<b>19.5</b>
90°	36	39	41	43
38°	<b>15</b>	<b>16</b>	<b>17</b>	<b>18</b>
100°	33	35	37	40

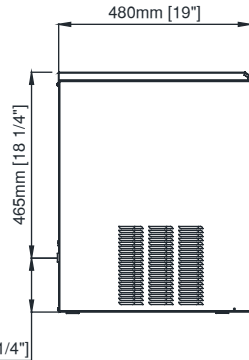
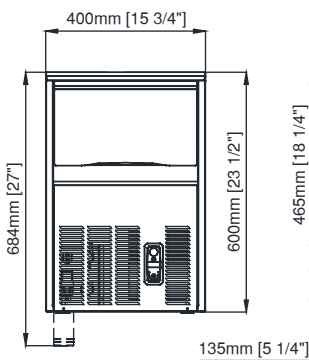

Kit 4 Feet Optional  
 Kit 4 piedini Optional  
Ø50mm H100-120 mm

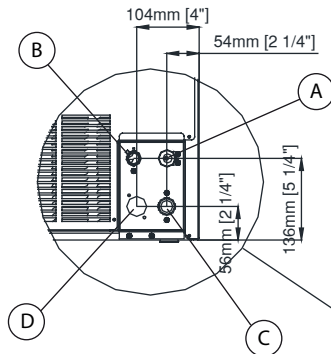
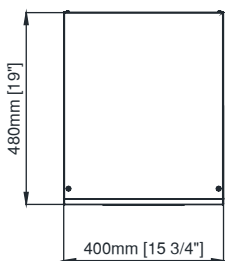

- A** Ingresso alimentazione elettrica  
Electrical cable supply
- B** Attacco scarico acqua Ø 20 mm  
Water outlet connection Ø 20 mm

- C** Attacco entrata acqua - 3/4" gas  
Water inlet connection - 3/4" gas
- D** Uscita acqua condensatore ad acqua Ø 20 mm  
Water outlet connection water condensation Ø 20 mm



### PANNELLO DI CONTROLLO - CONTROL PANEL



### CAPACITA' DEPOSITO - BIN CAPACITY

7 Kg - 15.4 lbs / 350 pcs

### DIMENSIONI - DIMENSIONS

LxPxH(mm): 400 x 480 x 600  
WxDxH(in): 16" 12/16 x 19" 14/16 x 24" 10/16

### DATI SPEDIZIONE / SHIPPING DATA

LxPxH(mm): 460 x 540 x 760  
WxDxH(in): 18" 2/16 x 21" 4/16 x 30" 15/16

### TIPO GHIACCIO - ICE TYPE

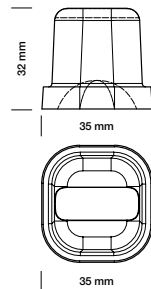

**20g**  
PESO GHIACCIO  
WEIGHT ICE

**18**  
PZ / CICLO  
PCS / CYCLE

### CONDIZIONI USO-OPERATING REQUIREMENTS



220-240V / 50Hz / 1



R134a GWP=1430

MIN

MAX

10°C (50°F)



40°C (104°F)

5°C (41°F)



35°C (95°F)

- 10 %



+ 10 %

1 BAR (14 PSI)



5 BAR (70 PSI)

Calore espulso - Rejected Heat  
Volume aria - Air Volume

**1056 W**  
**185 m³/h**

## Dati Tecnici - Specifications

	cond	comp. W	ABS. W	Fuse	Kwh/100Kg	l / h	kg	Lbs	kg	Lbs	Ton CO2 equiv.
<b>JS35 A</b>		755	470	10	32.6	2.58	36	79	44	97	0,329
<b>JS35 W</b>		755	470	10	25.1	31.2	36	79	44	97	0.286

## 24h Produzione Ghiaccio - Ice Production

### Raffreddamento ad aria - Air Cooled Unit

Temp. aria Air Temp.	Temp. acqua / Water Temp.			
	32°	21°	15°	10°
°C	32°	21°	15°	10°
°F	90°	70°	60°	50°
10°	<b>29</b>	<b>32</b>	<b>34</b>	<b>36</b>
50°	64	71	75	79
21°	<b>27</b>	<b>30</b>	<b>32</b>	<b>34</b>
70°	60	66	71	75
32°	<b>22</b>	<b>24</b>	<b>26</b>	<b>28</b>
90°	49	53	57	62
38°	<b>19</b>	<b>21</b>	<b>22</b>	<b>23</b>
100°	42	46	49	51

### Raffreddamento ad acqua - Water Cooled Unit

Temp. aria Air Temp.	Temp. acqua / Water Temp.			
	32°	21°	15°	10°
°C	32°	21°	15°	10°
°F	90°	70°	60°	50°
10°	<b>28</b>	<b>32</b>	<b>34</b>	<b>36</b>
50°	62	71	75	79
21°	<b>26</b>	<b>30</b>	<b>32</b>	<b>34</b>
70°	57	66	71	75
32°	<b>25</b>	<b>29</b>	<b>31</b>	<b>33</b>
90°	55	64	68	73
38°	<b>21</b>	<b>26</b>	<b>28</b>	<b>29</b>
100°	46	57	62	64



### PANNELLO DI CONTROLLO - CONTROL PANEL



### CAPACITA' DEPOSITO - BIN CAPACITY

7 Kg - 15.4 lbs / 350 pcs

### DIMENSIONI - DIMENSIONS

LxPxH(mm): 400 x 480 x 600

WxDxH(in): 16" 12/16 x 19" 14/16 x 24" 10/16

### DATI SPEDIZIONE / SHIPPING DATA

LxPxH(mm): 460 x 540 x 760

WxDxH(in): 18" 2/16 x 21" 4/16 x 30" 15/16

### TIPO GHIACCIO - ICE TYPE

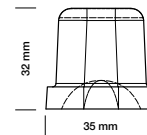

## 20g

PESO GHIACCIO  
WEIGHT ICE

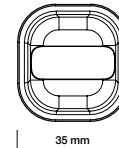

## 18

PZ / CICLO  
PCS / CYCLE

### CONDIZIONI USO-OPERATING REQUIREMENTS



220-240V / 50Hz / 1



R134a GWP=1430

MIN

MAX

10°C (50°F)



40°C (104°F)

5°C (41°F)



35°C (95°F)

- 10 %



+ 10 %

1 BAR (14 PSI)



5 BAR (70 PSI)

Calore espulso - Rejected Heat  
Volume aria - Air Volume

**1056 W**  
**185 m³/h**

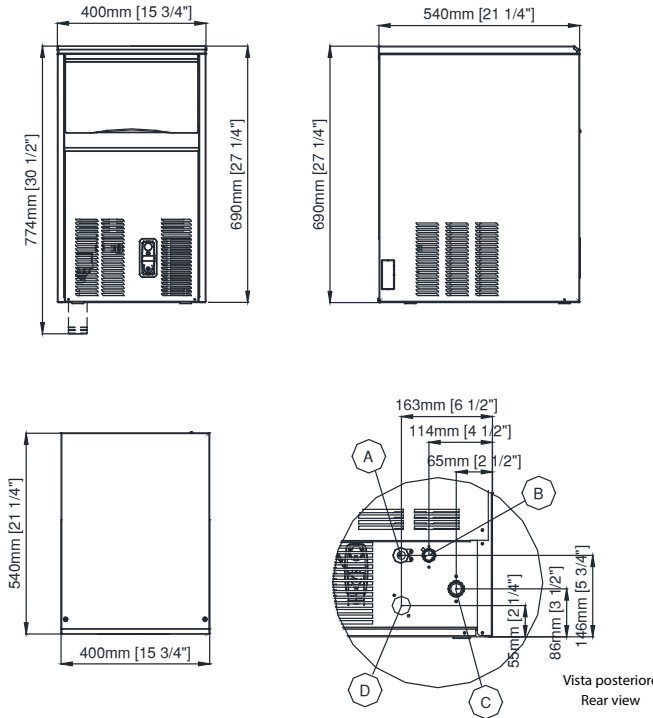

Kit 4 Feet Optional  
Kit 4 piedini Optional  
Ø50mm H100-120 mm

- A** Ingresso alimentazione elettrica  
Electrical cable supply
- B** Attacco scarico acqua Ø 20 mm  
Water outlet connection Ø 20 mm

- C** Attacco entrata acqua - 3/4" gas  
Water inlet connection - 3/4" gas
- D** Uscita acqua condensatore ad acqua Ø 20 mm  
Water outlet connection water condensation Ø 20 mm

## Dati Tecnici - Specifications

	cond	comp. W	ABS. W	Fuse	Kwh/100Kg	l / h	kg	Lbs	kg	Lbs	Ton CO2 equiv.
<b>JS40 A</b>		1144	590	10	39.4	2.73	39	86	48	106	0.33
<b>JS40 W</b>		1144	540	10	24.7	41.40	39	86	48	106	0.30

## 24h Produzione Ghiaccio - Ice Production

### Raffreddamento ad aria - Air Cooled Unit

Temp. aria Air Temp.	Temp. acqua / Water Temp.			
	32°	21°	15°	10°
°C	32°	21°	15°	10°
°F	90°	70°	60°	50°
10°	<b>32</b>	<b>37</b>	<b>40</b>	<b>41</b>
50°	71	82	88	90
21°	<b>27</b>	<b>32</b>	<b>35</b>	<b>37</b>
70°	60	71	77	82
32°	<b>21</b>	<b>26</b>	<b>28</b>	<b>30</b>
90°	46	57	62	66
38°	<b>18</b>	<b>23</b>	<b>25</b>	<b>27</b>
100°	40	51	55	60

### Raffreddamento ad acqua - Water Cooled Unit

Temp. aria Air Temp.	Temp. acqua / Water Temp.			
	32°	21°	15°	10°
°C	32°	21°	15°	10°
°F	90°	70°	60°	50°
10°	<b>33</b>	<b>38</b>	<b>41</b>	<b>42</b>
50°	73	84	90	93
21°	<b>29</b>	<b>35</b>	<b>38</b>	<b>40</b>
70°	64	77	84	88
32°	<b>28</b>	<b>34</b>	<b>37</b>	<b>39</b>
90°	62	75	82	86
38°	<b>26</b>	<b>33</b>	<b>36</b>	<b>38</b>
100°	57	73	79	84

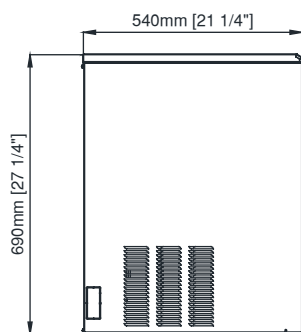
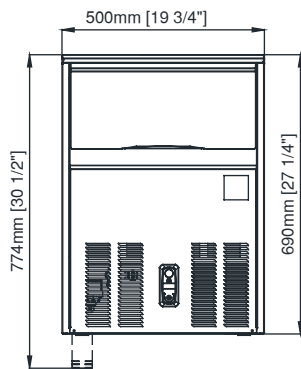

Kit 4 Feet Optional  
Kit 4 piedini Optional  
Ø50mm H100-120 mm

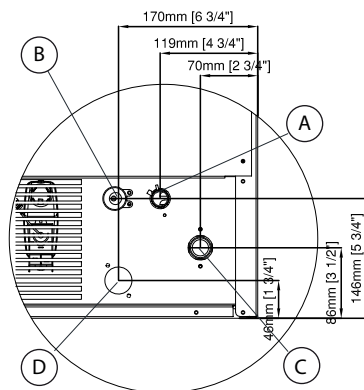
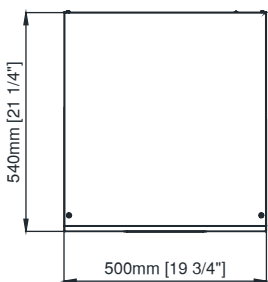

- A** Ingresso alimentazione elettrica  
Electrical cable supply
- B** Attacco scarico acqua Ø 20 mm  
Water outlet connection Ø 20 mm

- C** Attacco entrata acqua - 3/4" gas  
Water inlet connection - 3/4" gas
- D** Uscita acqua condensatore ad acqua Ø 20 mm  
Water outlet connection water condensation Ø 20 mm



### PANNELLO DI CONTROLLO - CONTROL PANEL



Interruttore On/OFF  
Switch ON/OFF

Vite regolazione  
dimensione ghiaccio  
Size ice regulation screw

### CAPACITA' DEPOSITO - BIN CAPACITY

15 Kg - 33 lbs / 750 pcs

### DIMENSIONI - DIMENSIONS

LxPxH(mm): 500 x 540 x 690

WxDxH(in): 20" 11/16 x 21" 4/16 x 27" 3/16

### DATI SPEDIZIONE / SHIPPING DATA

LxPxH(mm): 560 x 600 x 850

WxDxH(in): 22" 1/16 x 24" 10/16 x 33" 7/16

### TIPO GHIACCIO - ICE TYPE

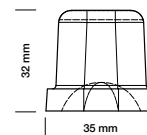

**20g**

PESO GHIACCIO  
WEIGHT ICE

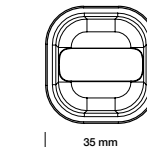

**28**

PZ / CICLO  
PCS / CYCLE

### CONDIZIONI USO-OPERATING REQUIREMENTS



220-240V / 50Hz / 1

R134a GWP=1430

MIN

MAX

10°C (50°F)



40°C (104°F)

5°C (41°F)



35°C (95°F)

- 10 %



+ 10 %

1 BAR (14 PSI)



5 BAR (70 PSI)

Calore espulso - Rejected Heat  
Volume aria - Air Volume

**1762 W**  
**185 m³/h**

## Dati Tecnici - Specifications

	cond	comp. W	ABS. W	Fuse	Kwh/100Kg	l / h	kg	Lbs	kg	Lbs	Ton CO2 equiv.
<b>JS50 A</b>		1161	680	10	32.4	4.60	48	106	56	123	0.50
<b>JS50 W</b>		1161	630	10	20.4	39.7	48	106	56	123	0.43

## 24h Produzione Ghiaccio - Ice Production

### Raffreddamento ad aria - Air Cooled Unit

Temp. aria Air Temp.	Temp. acqua / Water Temp.			
	32°	21°	15°	10°
°C	32°	21°	15°	10°
°F	90°	70°	60°	50°
10°	<b>47</b>	<b>49</b>	<b>50</b>	<b>52</b>
50°	104	108	110	115
21°	<b>41</b>	<b>43</b>	<b>45</b>	<b>47</b>
70°	90	95	99	104
32°	<b>33</b>	<b>35</b>	<b>37</b>	<b>39</b>
90°	73	77	82	86
38°	<b>27</b>	<b>30</b>	<b>32</b>	<b>34</b>
100°	60	66	71	75

### Raffreddamento ad acqua - Water Cooled Unit

Temp. aria Air Temp.	Temp. acqua / Water Temp.			
	32°	21°	15°	10°
°C	32°	21°	15°	10°
°F	90°	70°	60°	50°
10°	<b>48</b>	<b>50</b>	<b>52</b>	<b>54</b>
50°	106	110	115	119
21°	<b>44</b>	<b>47</b>	<b>49</b>	<b>51</b>
70°	97	104	108	112
32°	<b>42</b>	<b>45</b>	<b>47</b>	<b>49</b>
90°	93	99	104	108
38°	<b>40</b>	<b>43</b>	<b>45</b>	<b>47</b>
100°	88	95	99	104



### PANNELLO DI CONTROLLO - CONTROL PANEL



### CAPACITA' DEPOSITO - BIN CAPACITY

22 Kg - 48.5 lbs / 1100 pcs

### DIMENSIONI - DIMENSIONS

LxPxH(mm): 500 x 580 x 800

WxDxH(in): 20" 11/16 x 23" 13/16 x 31" 8/16

### DATI SPEDIZIONE / SHIPPING DATA

LxPxH(mm): 560 x 600 x 850

WxDxH(in): 22" 1/16 x 25" 3/16 x 33" 13/16

### TIPO GHIACCIO - ICE TYPE

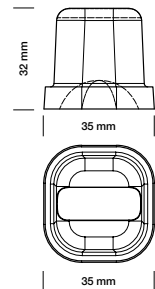

**20g**

PESO GHIACCIO  
WEIGHT ICE

**36**

PZ / CICLO  
PCS / CYCLE

### CONDIZIONI USO-OPERATING REQUIREMENTS



220-240V / 50Hz / 1



R134a GWP=1430

MIN

10°C (50°F)

5°C (41°F)

- 10 %

1 BAR (14 PSI)

MAX

40°C (104°F)

35°C (95°F)

+ 10 %

5 BAR (70 PSI)

Calore espulso - Rejected Heat  
Volume aria - Air Volume

**1750 W**  
**310 m3/h**

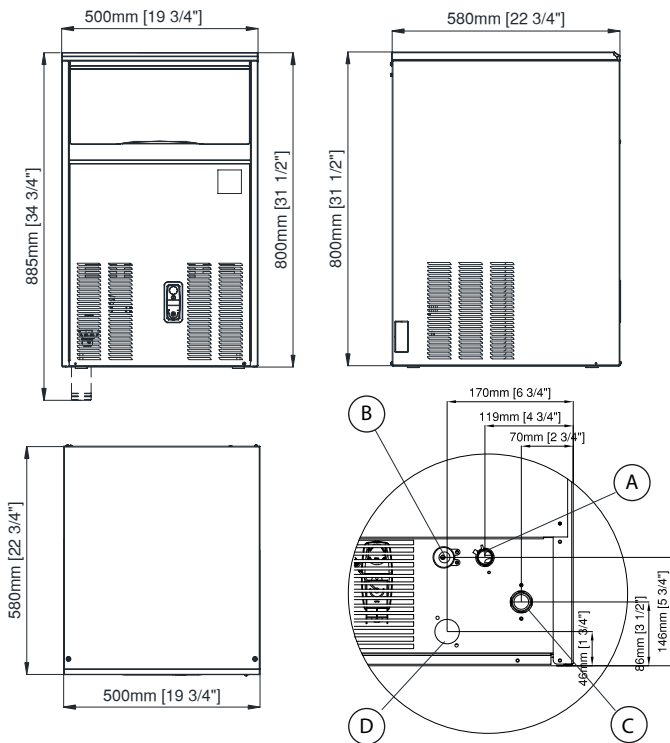

- A** Ingresso alimentazione elettrica  
Electrical cable supply
- B** Attacco scarico acqua Ø 20 mm  
Water outlet connection Ø 20 mm
- C** Attacco entrata acqua - 3/4" gas  
Water inlet connection - 3/4" gas
- D** Uscita acqua condensatore ad acqua Ø 20 mm  
Water outlet connection water condensation Ø 20 mm

Kit 4 Feet Optional  
Kit 4 piedini Optional  
Ø50mm H100-120 mm

## Dati Tecnici - Specifications

	cond	comp. W	ABS. W	Fuse	Kwh/100Kg	l / h	kg	Lbs	kg	Lbs	Ton CO2 equiv.
<b>JS70 A</b>		1317	880	10	26,3	5,98	57	126	69	152	0,56
<b>JS70 W</b>		1317	560	10	21,1	37,8	57	126	69	152	0,53

## 24h Produzione Ghiaccio - Ice Production

### Raffreddamento ad aria - Air Cooled Unit

Temp. aria Air Temp.	Temp. acqua / Water Temp.			
	32°	21°	15°	10°
°C	32°	21°	15°	10°
°F	90°	70°	60°	50°
10°	<b>64</b>	<b>68</b>	<b>70</b>	<b>72</b>
50°	141	150	154	159
21°	<b>57</b>	<b>61</b>	<b>63</b>	<b>65</b>
70°	126	134	139	143
32°	<b>51</b>	<b>55</b>	<b>57</b>	<b>59</b>
90°	112	121	126	130
38°	<b>40</b>	<b>43</b>	<b>45</b>	<b>47</b>
100°	88	95	99	104

### Raffreddamento ad acqua - Water Cooled Unit

Temp. aria Air Temp.	Temp. acqua / Water Temp.			
	32°	21°	15°	10°
°C	32°	21°	15°	10°
°F	90°	70°	60°	50°
10°	<b>62</b>	<b>67</b>	<b>68</b>	<b>70</b>
50°	137	148	150	154
21°	<b>57</b>	<b>62</b>	<b>64</b>	<b>66</b>
70°	126	137	141	146
32°	<b>51</b>	<b>56</b>	<b>58</b>	<b>60</b>
90°	117	128	132	137
38°	<b>49</b>	<b>53</b>	<b>56</b>	<b>57</b>
100°	108	117	123	126

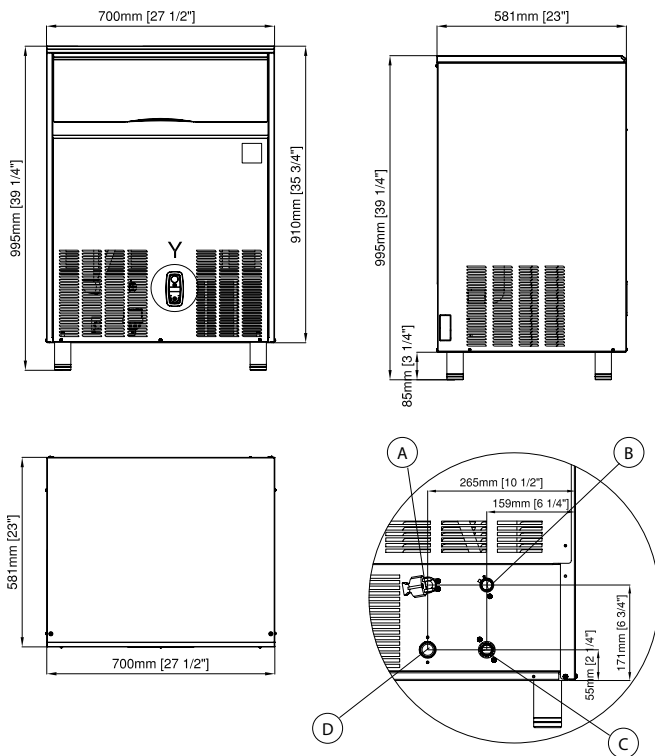

- A** Ingresso alimentazione elettrica  
Electrical cable supply
- B** Attacco scarico acqua Ø 20 mm  
Water outlet connection Ø 20 mm
- C** Attacco entrata acqua - 3/4" gas  
Water inlet connection - 3/4" gas
- D** Uscita acqua condensatore ad acqua Ø 20 mm  
Water outlet connection water condensation Ø 20 mm



### PANNELLO DI CONTROLLO - CONTROL PANEL



### CAPACITA' DEPOSITO - BIN CAPACITY

42 Kg - 93 lbs / 2100 pcs

### DIMENSIONI - DIMENSIONS

LxPxH(mm): 700 x 580 x 995

WxDxH(in): 29" 9/16 x 23" 13/16 x 39" 3/16

### DATI SPEDIZIONE / SHIPPING DATA

LxPxH(mm): 760 x 630 x 1070

WxDxH(in): 30" 15/16 x 25" 13/16 x 42" 2/16

### TIPO GHIACCIO - ICE TYPE

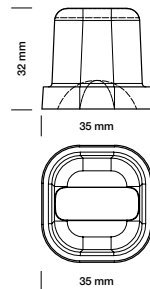

## 20g

PESO GHIACCIO  
WEIGHT ICE

## 56

PZ / CICLO  
PCS / CYCLE

### CONDIZIONI USO-OPERATING REQUIREMENTS



220-240V / 50Hz / 1



R134a GWP=1430

MIN

MAX

10°C (50°F)



40°C (104°F)

5°C (41°F)



35°C (95°F)

- 10 %



+ 10 %

1 BAR (14 PSI)



5 BAR (70 PSI)

Calore espulso - Rejected Heat  
Volume aria - Air Volume

**1968 W**  
**310 m3/h**

## Dati Tecnici - Specifications

	cond	comp. W	ABS. W	Fuse	Kwh/100Kg	l / h	kg	Lbs	kg	Lbs	Ton CO2 equiv.
<b>JS90 A</b>		1910	980	10	28,2	7,45	61	134	73	161	0,50
<b>JS90 W</b>		1910	820	10	19,7	51,4	61	134	73	161	0,53

## 24h Produzione Ghiaccio - Ice Production

### Raffreddamento ad aria - Air Cooled Unit

Temp. aria Air Temp.	Temp. acqua / Water Temp.			
	32°	21°	15°	10°
°C	32°	21°	15°	10°
°F	90°	70°	60°	50°
10°	<b>82</b>	<b>85</b>	<b>87</b>	<b>89</b>
50°	181	187	192	196
21°	<b>75</b>	<b>78</b>	<b>80</b>	<b>82</b>
70°	165	172	176	181
32°	<b>62</b>	<b>65</b>	<b>67</b>	<b>69</b>
90°	137	143	148	152
38°	<b>51</b>	<b>54</b>	<b>56</b>	<b>58</b>
100°	112	119	123	128

### Raffreddamento ad acqua - Water Cooled Unit

Temp. aria Air Temp.	Temp. acqua / Water Temp.			
	32°	21°	15°	10°
°C	32°	21°	15°	10°
°F	90°	70°	60°	50°
10°	<b>82</b>	<b>85</b>	<b>87</b>	<b>89</b>
50°	181	187	192	196
21°	<b>78</b>	<b>82</b>	<b>84</b>	<b>86</b>
70°	172	181	185	190
32°	<b>73</b>	<b>76</b>	<b>79</b>	<b>82</b>
90°	161	168	174	181
38°	<b>69</b>	<b>72</b>	<b>75</b>	<b>78</b>
100°	152	159	165	172

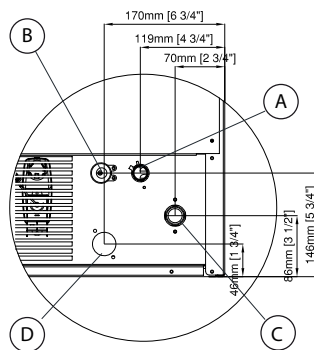
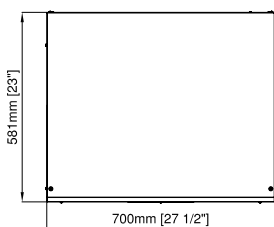
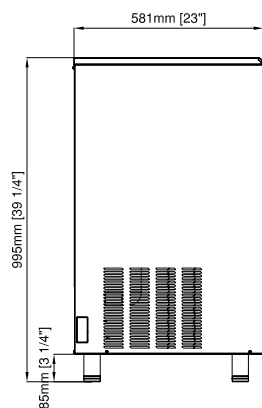
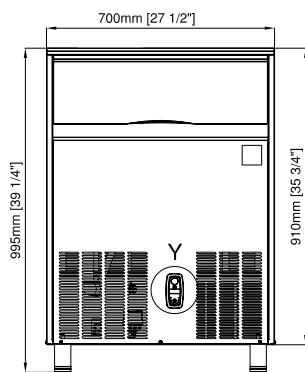

- A** Ingresso alimentazione elettrica  
Electrical cable supply
- B** Attacco scarico acqua Ø 20 mm  
Water outlet connection Ø 20 mm
- C** Attacco entrata acqua - 3/4" gas  
Water inlet connection - 3/4" gas
- D** Uscita acqua condensatore ad acqua Ø 20 mm  
Water outlet connection water condensation Ø 20 mm



### PANNELLO DI CONTROLLO - CONTROL PANEL



### CAPACITA' DEPOSITO - BIN CAPACITY

42 Kg - 93 lbs / 2100 pcs

### DIMENSIONI - DIMENSIONS

LxPxH(mm): 700 x 580 x 995

WxDxH(in): 29" 9/16 x 23" 13/16 x 39" 3/16

### DATI SPEDIZIONE / SHIPPING DATA

LxPxH(mm): 760 x 630 x 1070

WxDxH(in): 30" 15/16 x 25" 13/16 x 42" 2/16

### TIPO GHIACCIO - ICE TYPE

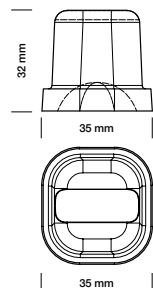

## 20g

PESO GHIACCIO  
WEIGHT ICE

## 56

PZ / CICLO  
PCS / CYCLE

### CONDIZIONI USO-OPERATING REQUIREMENTS



220-240V / 50Hz / 1



R134a GWP=1430

MIN

MAX

10°C (50°F)



40°C (104°F)

5°C (41°F)



35°C (95°F)

- 10 %



+ 10 %

1 BAR (14 PSI)



5 BAR (70 PSI)

Calore espulso - Rejected Heat  
Volume aria - Air Volume

**2865 W**  
**450 m<sup>3</sup>/h**